

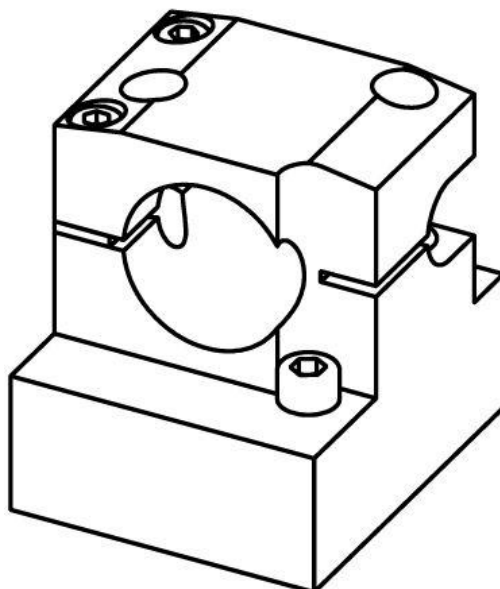





VDF-HF30

Machine: CITIZEN Cincom
Type: M12/M16
Emplacement, N°: Tourelle
Travail sur: Broche principale / Broche de reprise
Type de travail: 
n_{max}: - [rpm]
i (n_i / n_o): -
Attachement: Broche Ø30
Refroidissement : Ø
Pression maximale: [bar]
Infos:

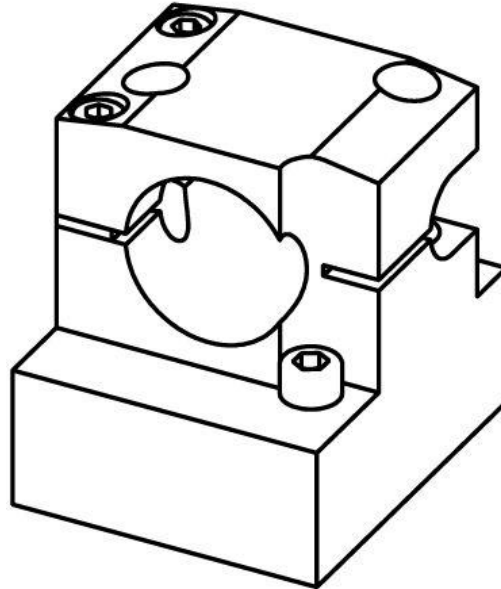
VDF-HF30

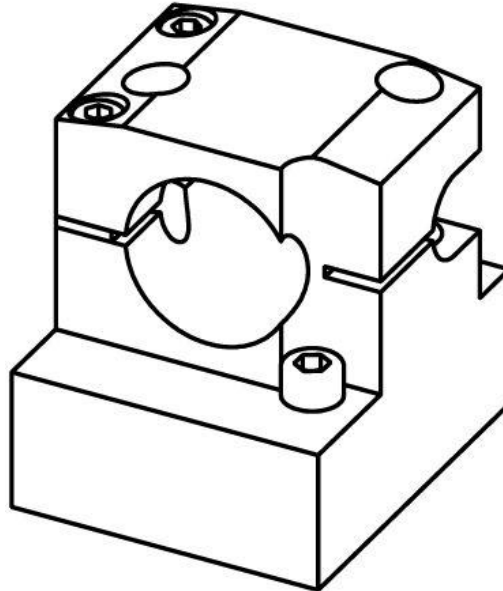
Machine: CITIZEN Cincom
Type: M12/M16
Location, N°: Turret
Work on: Main spindle / Back spindle
Type of work: 
n_{max}: - [rpm]
i (n_i / n_o): -
Attachement: Spindle Ø30
Coolant : Ø
Maximum pressure: [bar]
Infos:

VDF-HF30

Maschine: CITIZEN Cincom
Typ: M12/M16
Position, N°: Revolver
Arbeit über: Hauptspindel / Abgreifspindel
Arbeitstyp: 
n_{max}: - [rpm]
i (n_i / n_o): -
Befestigung: Spindel Ø30
Kühlmittel: Ø
Maximaler Druck: [bar]
Infos:

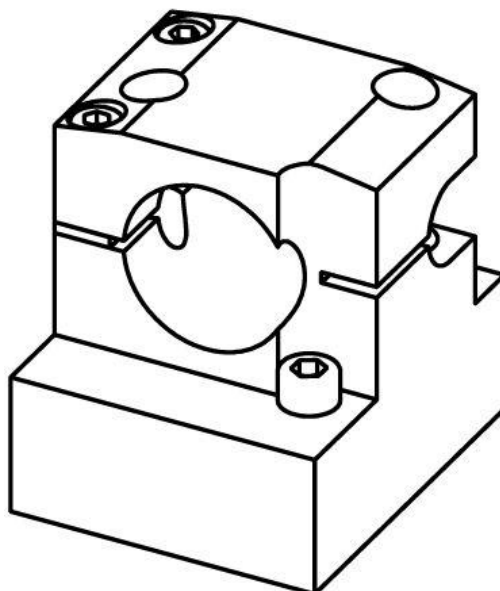
VDF-HF30

Macchina: CITIZEN Cincom
Tipo: M12/M16
Posizione, N°: Toretta
Lavoro al: Mandrino principale / Contromandrino
Tipo di lavoro: 
n_{max}: - [rpm]
i (n_i / n_o): -
Ataccamento: Mandrino Ø30
Refrigerante Ø
Pressione massima: [bar]
Informazioni: