

MEU208-MHF

Français

1. Pour fixer le porte-outil sur la machine, introduire la queue et utiliser la goupille pour le positionnement.
Serrer, les 5 vis de fixations (important, veillez à ce que les vis aient la même force de serrage).

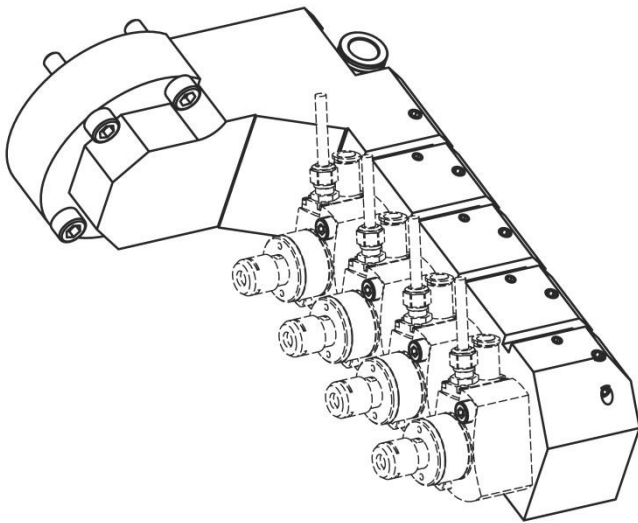

2. Serrer légèrement, les vis de fixation (important, veillez à ce que les vis aient la même force de serrage).

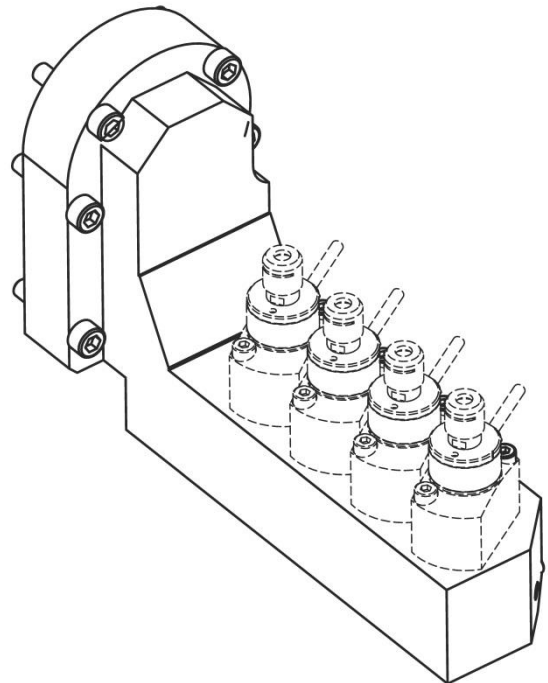

MEU208-MHF

English

1. To fix the tool holder to the machine, introduce the shank and use the pin for the positioning.
Then tighten the 5 screws of fixations (Important, make sure that the screws have the same strength of tightening).

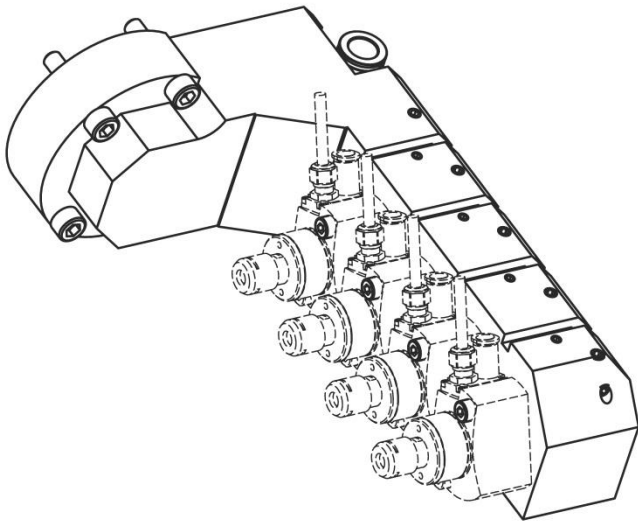

2. Then tighten lightly the fixing screws (important, make sure that the screws have the same clamping force).

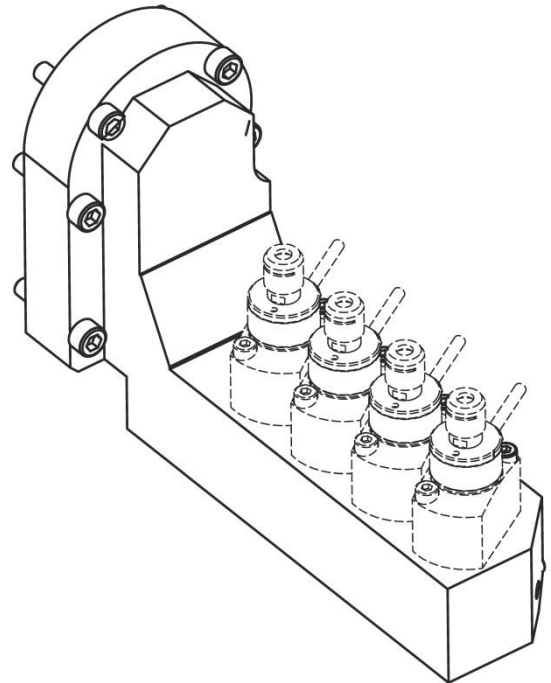

MEU208-MHF

Deutsch

1. Um den Werkzeughalter an der Maschine zu befestigen, führen Sie der Schaft hinein und zentrieren Sie es mit dem Positionierstift.
Ziehen Sie die 5 Schrauben an (Wichtig, beobachten Sie darauf, dass die Schrauben dieselbe Spannkraft haben).

2. Ziehen Sie die Schrauben leicht an (Wichtig, beobachten Sie darauf, dass die Schrauben dieselbe Spannkraft haben).

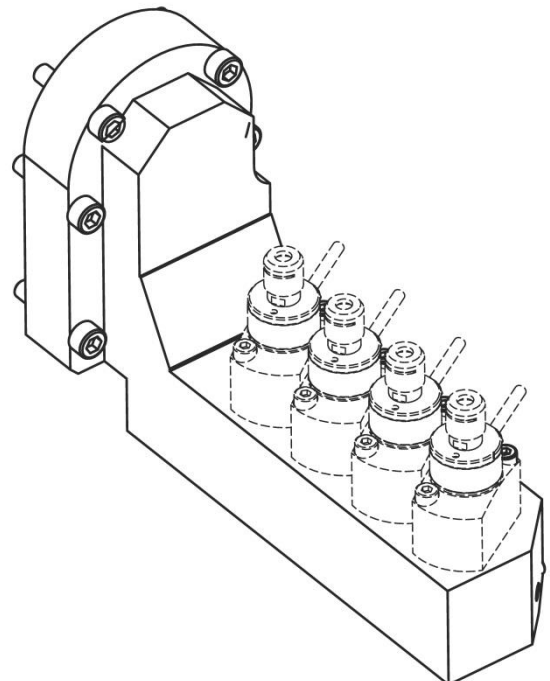
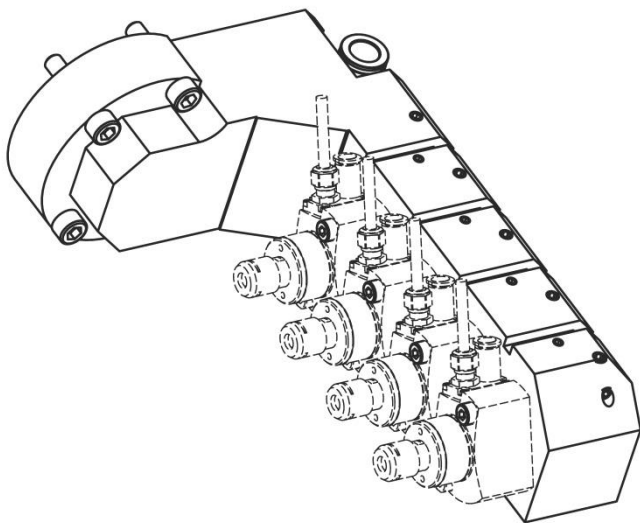

MEU208-MHF

Italiano

1. Per fissare il porta-utensile sulla macchina, introdurre il codolo e utilizzare il pin per il posizionamento.
Serrare le 5 viti di fissaggio (importante, guardare che le viti hanno la stessa forza di serraggio).

2. Serrare leggermente le viti di fissaggio (importante, assicurarsi che le viti hanno la stessa forza di serraggio).

